

Control Centre (Interface)



Technical data

Dimensions:	220mm x 219mm x 100mm	
Operational voltage:	230V/50Hz	
Control system power consumption:	ca. 10VA	
Switching capacity:	Aux. 1: potential-free	max. 8A (230V)
	Aux. 2: potential-free	max. 8A (230V)
	Aux. 3: potential-free	max. 8A (230V)
Protection class:	IP 40	
Connection for dosing systems	RS 485	
Connection for air conditioning	RS 485	
osf bus	RS 485	
External switch for	Aux. 1:	12V
	Aux. 2:	12V
	Aux. 3:	12V

Contents

Technical data	1
Displays and controls	3
Individual button functions	3
Carrying out changes	4
Setting time and date	4
Cancelling programming without saving.....	4
Setting the language	4
Resetting display to initial setting	5
Setting runtime limitation for attraction.....	5
Allocating names for the Aux.1, Aux.2 and Aux.3 buttons on the monitor	5
Allocating a name to the Aux.E2000 button on the monitor.....	6
Swimming pool cover	6
Allocation of rights for changing filter technology settings	7
Dosing system selection	7
Allocation of rights for changing dosing unit settings	8
Dosing units with 0 to 20 mA (4 to 20 mA) interface	9
Selecting and configuring the adapter	9
Selection of air conditioning / dehumidification equipment	10
Installation	10
Electrical power supply	10
Circuit diagram	11
Low voltage cabling:	11
POOL-CONTROL “EUROMATIK“	11
Attractions.....	11
Switches for attractions at pool edge	12
Dosing systems.....	12
Dosing units with 0 to 20 mA (4 to 20 mA) interface	12
Adapter connection.....	13
Air conditioning equipment.....	12
Touchscreen monitor	13
Swimming pool cover	13

Displays and controls

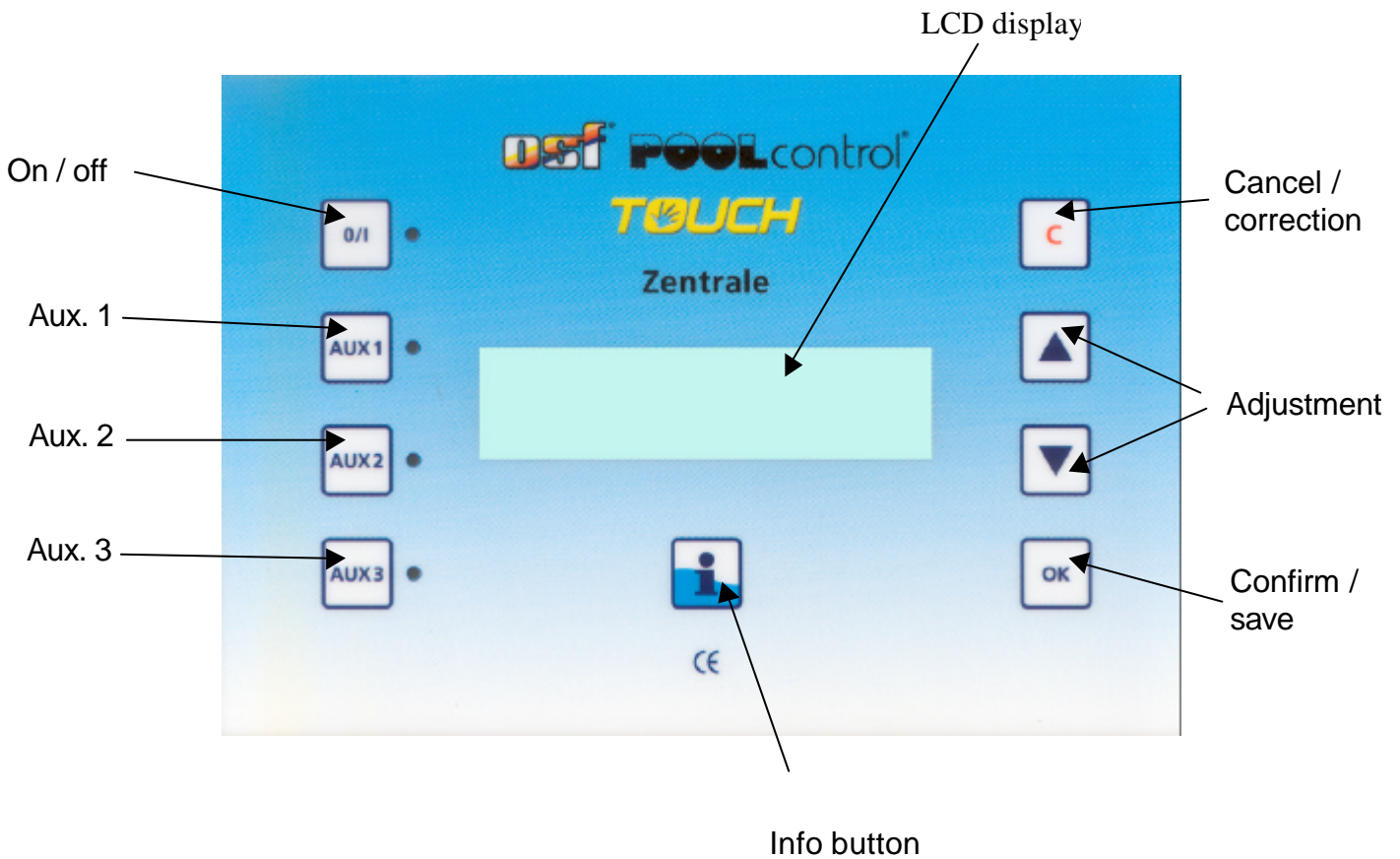

Individual button functions

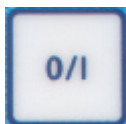

This button is used to switch the control centre and the touch panel on and off.



This button is used to switch the connected consumers on and off.



This button is used to switch the connected consumers on and off.



This button is used to switch the connected consumers on and off.



This button is used to call up, configure and program a wide range of functions.



This button is used to cancel a process without saving.



This button is used to increase a value during programming.



This button is used to reduce a value during programming.

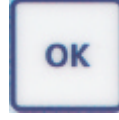



This button is used to save the value shown on the display.

Carrying out changes



Setting time and date





Press this button and hold it down for 3 seconds.
The symbol for programming mode is visible top left on the display.
The hour display blinks =>

Carry out the setting for the hour by using the  or  buttons



Press the  button again
The minute display blinks =>

Set the minute using the  or  buttons



Press the  button again
The day display (date) blinks =>

Set the day (date) using the  or  buttons

Press the  button again
The month display blinks =>

Set the month using the  or  buttons

Press the  button again
The year display blinks =>

Set the year using the  or  buttons

Press the  button again
Time and date are saved

Cancelling programming without saving





The programming process is cancelled if you press this button. Any settings you have made will not be saved.

Setting the language



Press this button several times until the word "**Language**" is displayed in the top display line:

Press the  button =>
The current language will be displayed blinking in the bottom line.

Set the language selection using the  or  buttons

Press the  button again

The selected language will be applied and saved.

Resetting display to initial setting



The display returns to the initial setting 10 seconds after the last button is pressed. If you press this button you can cause this to happen at any time.

Setting runtime limitation for attraction





Press this info button several times until the word "**Aux. N1**" is displayed in the top display line:

Press the  button =>

An arrow will now blink in front of the "**Timer**" lettering

Press the  button =>

Use the  or  buttons to select a maximum runtime or to deactivate runtime limitation.

If runtime limitation is activated, the connected consumers will be automatically switched off after the set period has expired.

Press the  button again

The selected setting will be applied and saved.

Runtime limitation can be selected between 0 and 30 minutes

The settings for "**Aux. N2**" and "**Aux. N3**" are carried out in the same manner.

Allocating names for the Aux.1, Aux.2 and Aux.3 buttons on the monitor



You can allocate names and symbols for the *Aux. 1*, *Aux. 2* and *Aux. 3* buttons on the monitor.





Press this info button several times until the word "**Aux. N1**" is displayed in the top display line:

Press the  button =>

An arrow will now blink on the display

You can now move the arrow in front of the "**Name**" word using the  or  buttons.

Press the  button =>

You can now select a name for the button by using the  or  buttons.

Press the  button =>

The name and the corresponding symbol will be applied and saved.

Next time you press the AUX. button on the monitor or in the control centre, the selected name will be applied and displayed on the monitor.

The symbol will be automatically allocated to the name.

The settings for "**Aux. 2**" and "**Aux. 3**" are carried out in the same manner. Only the **Aux. E2000** button may be used for a swimming pool cover. The switching output is located in the EUROMATIK.

Allocating a name to the Aux.E2000 button on the monitor



You can allocate a name and symbol to the *Aux. E2000* on the monitor.



Press this info button several times until the word "**Aux. E2000**" is displayed:

Press the  button =>

The "No name" lettering will blink in the display

You can now select a name for the button by using the  or  buttons.

Press the  button =>

The name and the corresponding symbol will be saved.

Next time you press the AUX. button on the monitor or in the control centre, the selected name will be applied and displayed on the monitor.

The symbol will be automatically allocated to the name.

The designation E2000 is the abbreviation for the EUROMATIK-2000. The switching output is located in the EUROMATIK-2000 filter control unit.

Swimming pool cover

If the swimming pool cover is to be switched using Pool-Control-TOUCH, all switches which could be used (Euromatik 2000, Touch Monitor) must be located in an exposed location from which there is an uninterrupted view of the swimming

pool. It is imperative that you ensure the swimming pool is not being used before closing the cover. You must ensure that all switches relevant to the cover are not accessible by unsupervised children.

The switch for the swimming pool cover is located on the monitor.

Note:

Only the *E2000* button may be used for the swimming pool cover. If this button is used to switch the swimming pool cover, the button must also be allocated the appropriate name. You can find information about this procedure under "Allocating the name for the Aux. button in the monitor" in this manual.

If the *E2000* is defined for the swimming pool cover, the switching function via computer or Internet is automatically blocked for the Pool-Control-TOUCH-2. The current cover status (closed or open) is, however, still displayed on the computer.

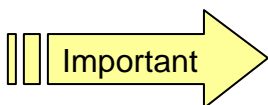

Allocation of rights for changing filter technology settings

As delivered, the monitor can be used to change the required filter control unit water temperature. The other filter control unit parameters can be read but not changed.



To change these rights, press the Info button several times until the adjacent message is displayed:

Press the button =>

The following message is now displayed:

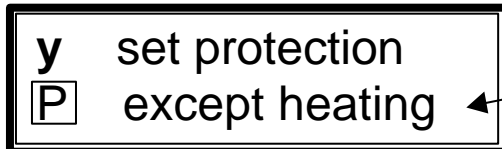

The target temperature can be adjusted on the monitor. All other functions are blocked.

Use the or buttons to select between the following settings:

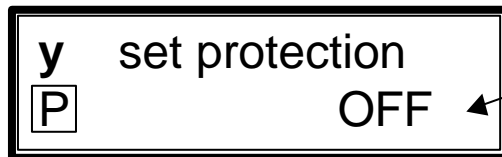

The setting block is switched off. All filter technology settings can now be carried out on the monitor.

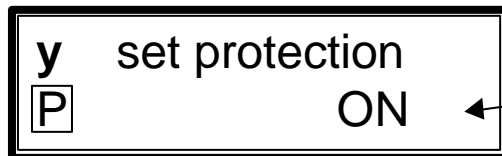

The setting block is switched on. No filter technology settings can now be carried out on the monitor.

Press the button =>
The selected setting is saved

Dosing system selection

This control system can be connected with complete dosing systems. Since various dosing devices use differing program structures, it is necessary to

select the appropriate dosing device in the menu or the Pool-Control-TOUCH control centre.





To access this selection menu, press the Info button several times until the adjacent message is displayed:

Press the button =>

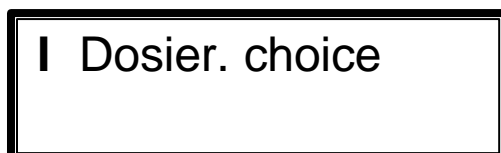
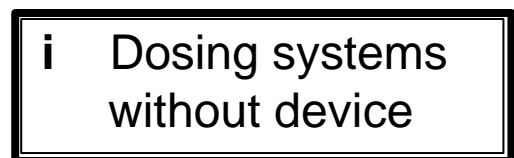
The following message is now displayed:



Press the  button again =>

Use the  or  buttons to select the existing dosing systems: All possible devices are displayed in the bottom line.

Once you have selected the dosing equipment, press the  button =>
The setting is saved The selected dosing unit is displayed on the monitor.

Allocation of rights for changing dosing unit settings

The supplied values for the dosing unit are displayed on the monitor in the ex-works condition. Changing target values and equipment parameters is blocked.

If these values are to be adjusted on the monitor, the block must be removed first =>



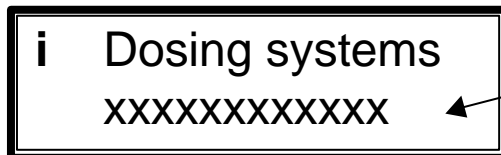

To change these rights, press the Info button several times until the message below is displayed:



Display of selected dosing unit

Press the  button again =>

You can now select the set.block menu command using the  or  buttons

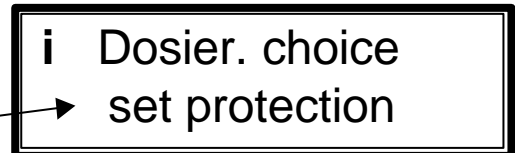

Press the  button =>

Use the  or  buttons to select between the following settings:

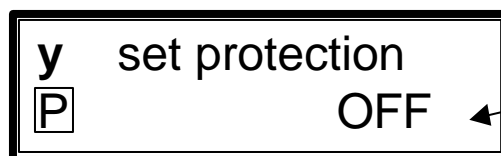

The setting block is switched off. A range of settings for the dosing unit can now be carried out on the monitor.

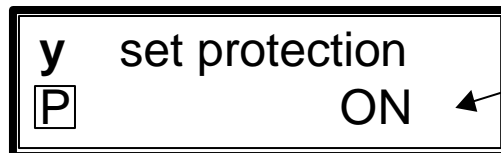

The setting block is switched on. No dosing unit settings can now be carried out on the monitor.

Press the  button =>
The selected setting is saved

Dosing units with 0 to 20 mA (4 to 20 mA) interface

Since not all dosing units have an RS-485 interface, there is a facility for connecting these devices to the Pool-Control-TOUCH using an analog 0 to 20 mA or 4 to 20 mA Interface. You can

obtain a suitable adapter for connecting these dosing units from [img alt="Hera logo" data-bbox="748 124 771 141"]. This adapter is adjusted to the dosing unit output signals as described below.

Selecting and configuring the adapter





To access this selection menu, press the Info button several times until the adjacent message is displayed:

i Dosing systems without device

Press the  button =>
The following message is now displayed:



i Dosier. choice

Press the  button again =>
Select the adapter using the  or  buttons. The "SENECA" designation is now displayed in the bottom line.

Adapter 0 (4) to 20 mA

i Dosing systems of PCT-Analog

Once you have selected the of "PCT Analog" adapter, press the  button =>
The setting is saved. The adapter can now be configured



Use the  or  buttons to select between 0 – 20 mA or 4 – 20 mA. The set value must be identical to the dosing unit output signal.

Select current

i config. pH
→ 0-20mA 0.0-14

Press the  button, the set value will be saved.



The next stage is to select the measuring range which the dosing unit possesses.

The lower value of the measuring range is selected using the  or  buttons. The set value must be identical to the dosing unit measuring range.

i config. pH
0-20mA 0.0-14

Setting the lower value

Press the  button, the set value will be saved.

The upper value of the measuring range is selected using the  or  buttons. The set value must be identical to the dosing unit measuring range.

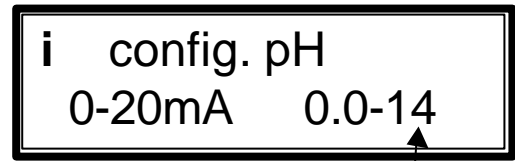

Setting the upper value

Press the  button, the set value will be saved.

The settings for the pH value are now complete. The next things to do is to carry out the same procedure for setting the ORP (Redox), free chlorine and compound chlorine.

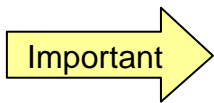

The measuring range and the current range for the dosing unit must always be set. If not, the monitor will display incorrect values!.

Selection of air conditioning / dehumidification equipment

The control system can be connected to a range of air conditioning or dehumidification devices. Since different equipment has differing program





To access this selection menu, press the Info button several times until the adjacent message is displayed:

structures, it is always necessary to select the appropriate dehumidification device at the Pool-Control-TOUCH control centre.

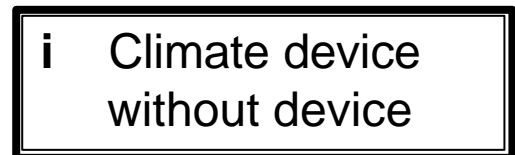
Press the  button =>
The following message is now displayed:



Press the  button again =>

Use the  or  buttons to select the existing air-conditioning equipment: All possible devices are displayed in the bottom line.

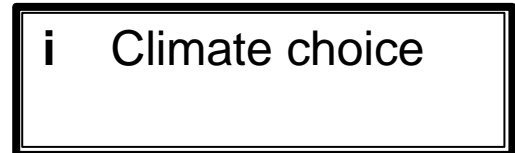

Once you have selected the air conditioning equipment, press the  button =>
The setting is saved. The selected air conditioning equipment is displayed on the monitor.

Installation

The controller must be permanently installed suitably protected against moisture in accordance with its protection class. The device power supply must be provided via an all-pole mains switch with a contact opening with the least 3 mm and a residual current circuit breaker of $I_{FN} \leq 30\text{mA}$. **The device must be isolated before opening the housing.**

Electrical power supply

Electrical power supply connections, in addition to alignment and service work, may only be carried out by approved electricians. The attached circuit diagrams and all applicable safety regulations must be observed. All conductive components must be included in the equipotential bonding.

Circuit diagram

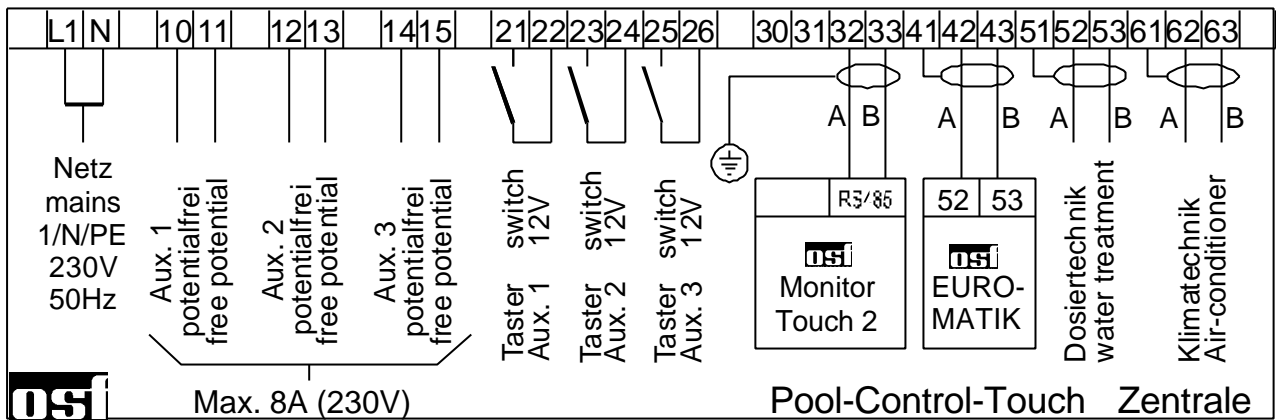

Low voltage cabling:

Low voltage cables may not be routed together with three-phase or alternating current cables in the same cable duct. Routing of low voltage cables in the vicinity of three-phase alternating current cables should be avoided if possible.

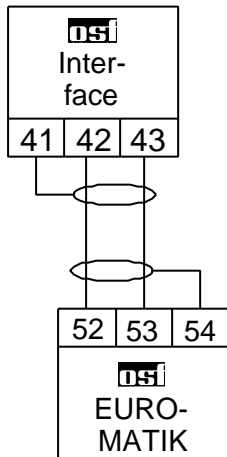

POOL-CONTROL "EUROMATIK"

An RS-485 interface is provided for connection to the EUROMATIK. A 2-core (twisted pair) cable with a cross-section of a least 0.22 mm² must be used for the connection. (e.g. Li2YCY(TP) 2 x 0,22 mm²). Screening is used to improve the electromagnetic compatibility (EMC). The cable length may not exceed 1200 m.

Attractions

Floating contacts 10/11 (button Aux.1), 12/13 (button Aux. 2), and 14/15 (button Aux. 3) are available for switching attractions. These contacts may be loaded with a maximum 8A and 230 V/. A 230V output is available in the EUROMATIK for button Aux 4.

nsi additional control cabinets can be used for switching of three-phase devices with built-in motor protection (item no.: 300.240.0000).

Switches for attractions at pool edge

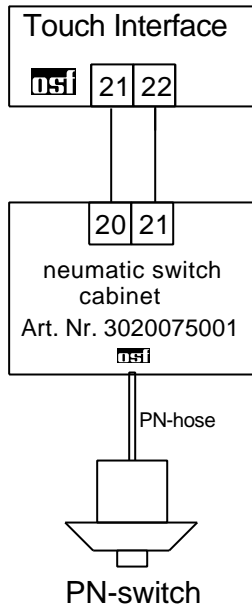

Attractions can also be switched using a button installed at the edge of the pool in addition to switching via the monitor and the control centre. The terminals are provided with safety low voltage. The installation also needs to comply with the requirements for safety low voltage.

If the attractions are to be switched using air pressure (pneumatically), a tsi PN potential-free switch cabinet (item no.: 3020075001) must be used. This switch cabinet is switched between the pneumatic button and the Pool-Control-TOUCH interface. The pneumatic switch is installed in the pool edge.

Dosing systems

An RS-485 interface is provided for connection to the dosing systems. A 2-core (twisted pair) cable with a cross-section of a least 0.22 mm² must be used for the connection. (e.g. Li2YCY(TP) 2 x 0,22 mm²). Screening is used to improve the electromagnetic compatibility (EMC). The cable length may not exceed 1200 m.

Caution:

Connections A and B may not be swapped.

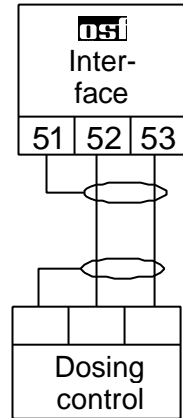

Air conditioning equipment

An RS-485 interface is provided for connection to the air conditioning equipment. A 2-core (twisted pair) cable with a cross-section of a least 0.22 mm² must be used for the connection. (e.g. Li2YCY(TP) 2 x 0,22 mm²). Screening is used to improve the electromagnetic compatibility (EMC). The cable length may not exceed 1200 m.

Caution:

Connections A and B may not be swapped.

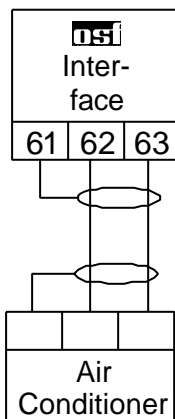

Dosing units with 0 to 20 mA (4 to 20 mA) interface

Since not all dosing units have an RS-485 interface, there is a facility for connecting these devices to the Pool-Control-TOUCH using an analog 0 to 20

mA or 4 to 20 mA Interface. You can obtain a suitable adapter for connecting these dosing units from tsi.

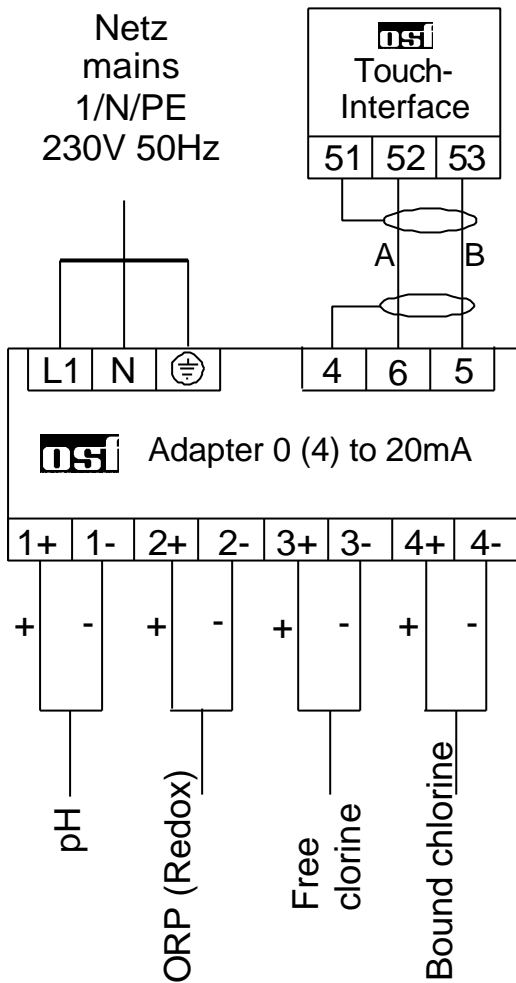

Adapter connection

An RS-485 interface is provided for connecting the adapter to the touchscreen control centre. A 2-core (twisted pair) cable with a cross-section of a least 0.22 mm² must be used for the connection. (e.g. Li2YCY(TP) 2 x 0,22 mm²). Screening is used to improve the electromagnetic compatibility (EMC). The cable length may not exceed 1200 m.

Caution:

Connections A and B may not be swapped.

The 4 analog inputs on the adapter have the same chassis earth. For this reason this adapter is only suitable for dosing units which do not require potential separation. Please enquire about adapters with potential separation from **nsi**.

Touchscreen monitor

An RS-485 interface is provided for connecting to the touchscreen monitor. A screened, 4-core cable with a cross-section of at least 0.75 mm² is used for the connection. The screening serves to improve electromagnetic compatibility (EMC) and is connected to the protective earth in the Pool-Control-TOUCH control centre. The cable length may not exceed 100 m. The Pool-Control-TOUCH-2 monitor is connected to the computer network using a suitable network cable (LAN cable). The cable type depends on the network used. A 230 V/12 V power unit is provided for the monitor power supply.

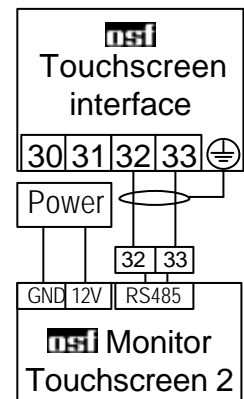

Swimming pool cover

If the swimming pool cover is to be switched using Pool-Control-TOUCH, all switches which could be used (Euromatik, Touch Monitor) must be located in an exposed location from which there is an uninterrupted view of the swimming pool. It is imperative that you ensure the swimming pool is not being used before closing the cover. You must ensure that all switches relevant to the cover are not accessible by unsupervised children.

A suitable swimming pool cover can be directly switched with the 230 V output from terminals U4 and N on the EUROMATIK. This switching output is triggered by the E2000 button on the monitor.

Since was such a huge range of colours available on the market it is often necessary to use an additional switch cabinet. You can purchase suitable additional switch cabinets from ourselves.

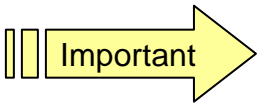

Only the E2000 button may be used for the swimming pool cover. If this button is used to switch the swimming pool cover, the button must also be allocated the appropriate name. You can find information about this procedure under "Allocating the name for the Aux. button in the monitor" in this manual.

