

Installation and operating instructions

osf whirlpool control



Art.Nr.3062911003

Technical data:

Dimensions:	325mm x 280mm x 160mm	
Operating voltage:	400V/50Hz	
Power input of control system:	approx. 10VA	
Switching capacity:	Whirlpool pump:	max. 3.0 kW (AC3)
	Heating:	max. 0.4 kW (AC1)
	Chemical control:	max. 0.4 kW (AC1)
	Additional output:	max. 3A (AC1)
Protection class:	IP 40	

Function:

The **osf** Whirlpool Control enables a 230V alternating current filter pump to be switched in a timed manner according to a freely programmable daily or weekly schedule.

Control lamps on the front cover, enabling verification to be made at any time, indicate the operation of the filter pump and the heating.

The whirlpool pump is protected against overload by an electronic motor protection (current range is infinitely variable up to 8A).

The Whirlpool Control can be remotely operated by an external control unit.

Terminals for remote control switches enable the filter system to be remote controlled.

Filtering and heating

Whilst the filter pump is running, the heating of the whirlpool is controlled by the electronic temperature control. During filter pauses the heating is automatically switched off by the internal interlocking. When the nighttime temperature reduction is active, the water continues to be temperature-controlled during filter pauses as well. The option of connecting a safety thermal relay or flow-control device provides additional protection against the heating system overheating. The desired temperature of the whirlpool water can be selected and the heating can be switched on or off on the front panel. Both a live contact (terminal U2) as well as a floating contact (terminals 19 + 20) are provided for connecting the heating. Terminals 19 + 20 can be used for connecting a centralized fault alarm, as required.

Table of contents

<u>Technical data:</u>	1
<u>Function:</u>	1
Filtering and heating	1
Night-time temperature reduction	3
Light	3
Blower	3
Whirlpool pump	3
Level control	3
Backwash control	3
Chemical control	4
Motor winding protection contact	4
<u>Installation</u>	4
<u>Electrical connection</u>	4
Supply connection using a 400V three-phase current whirlpool pump:	4
Supply connection using a 230V alternating current whirlpool pump:	5
Connection of a coin-operated timer:	5
Heating and centralized fault indication:	5
Level control and backwash control:	6
Lighting, chemical control and remote control switch:	7
Connecting filter pump and blower:	7
<u>Switching bigger loads:</u>	7
<u>Temperature detector:</u>	8
<u>External operating panel:</u>	8
<u>Sensor Armatur</u>	8
<u>Control elements on the front cover:</u>	9
<u>Control elements on the Sensor armatur:</u>	11
<u>Adjustment of the temperature feedback control:</u>	12
<u>Fuses:</u>	12
<u>Electronic motor protection:</u>	12
<u>Coding switch:</u>	13
Day or week timer:	13
Centralized fault indication:	13
<u>Service Terminal:</u>	14

Night-time temperature reduction

Outside of filtering times the water may be heated to a lower temperature by means of the nighttime temperature reduction. If the water temperature falls below the pre-set value (nighttime temperature reduction) outside the filtering times, both the heating and the filter pump are switched on. Activation of the nighttime temperature reduction and setting the temperature is carried out by a qualified swimming pool technician with the aid of an **ISI** Service Terminal. The temperature is set in the menu item Night Time Reduction; switching on or off is carried out in the menu item Priority Switching of the Heating (see below). The nighttime temperature reduction is switched off when shipped.

Light

The underwater lighting can be switched on or off by means of the pushbutton key in the front cover and the detector armatur installed in the edge of the tub. If the dry-run protection of the **ISI** collection tank control NR-12-TRS-2 is triggered, the light switches off automatically to prevent overheating. A safety transformer is required for supplying power to the floodlight.

Blower

The whirlpool blower can be switched on or off by means of the Sensor armatur installed in the edge of the tub. If the run-time limitation is activate, the blower switches off automatically at the end of the time set. The blower may be switched off by operating the key in the Sensor armatur even though the runtime limitation is active. Switching a code switch activates the run-time limitation; the time is set with the aid of an **ISI** Service Terminal (see below).

Whirlpool pump

The whirlpool pump can be switched on or off by means of the Sensor armatur installed in the edge of the tub. If the runtime limitation is activated, the whirlpool pump switches off automatically at the end of the time set. The whirlpool pump may be switched off by operating the key in the Sensor armatur even though the runtime limitation is active. Switching a coding switch activates the runtime limitation; the time is set with the aid of an **ISI** Service Terminal (see below).

Level control

Terminals for an electronic level control NR-12-TRS-2 (product code 3030000020) enable the water level in the whirlpool to be controlled conveniently and automatically. In addition, the filter pump is also protected from damage that may be caused by operating the filter system without water.

Backwash control

Terminals for an **ISI** EUROTRONIK-10 (voltageless, product code 3104800201) enable the control of the whirlpool to be upgraded to an automatic filtering and backwash control.

Chemical control

Terminals 21 + 22 are voltageless and can therefore be used for a chemical control as required. During filtering times the relay contact between terminals 21 and 22 is closed; outside filtering times this relay contact is open. This contact may be subjected to a voltage of no more than 230V and a power of no more than 400W ($\cos \varphi=1$).

Motor winding protection contact

The terminals for the motor winding protection contact enable a motor winding protection contact switch to be connected, which is integrated into the motor winding of the filter pump. If this contact opens, e.g. due to the motor winding overheating, the filter pump and, automatically, the heating and dosing, are switched off. As soon as the motor winding protection contact closes after the motor winding has cooled down, the units switch on again automatically. No manual reset is necessary. The terminals for the motor winding protection contact are allocated 230V.

Installation

The control device must be installed protected from moisture in accordance with its protection class. The power supply of the equipment must be connected using an all-pole mains switch with a contact gap of at least 3mm and an earth-leakage protection breaker with $I_{FN} \leq 30\text{mA}$. **Before opening the casing the device must be isolated from supply.**

Electrical connection

The electrical connection as well as adjustment work and servicing may only be carried out by an approved electrician! The enclosed terminal diagrams and the relevant current safety regulations must be observed.

Supply connection using a 400V three-phase current whirlpool pump:

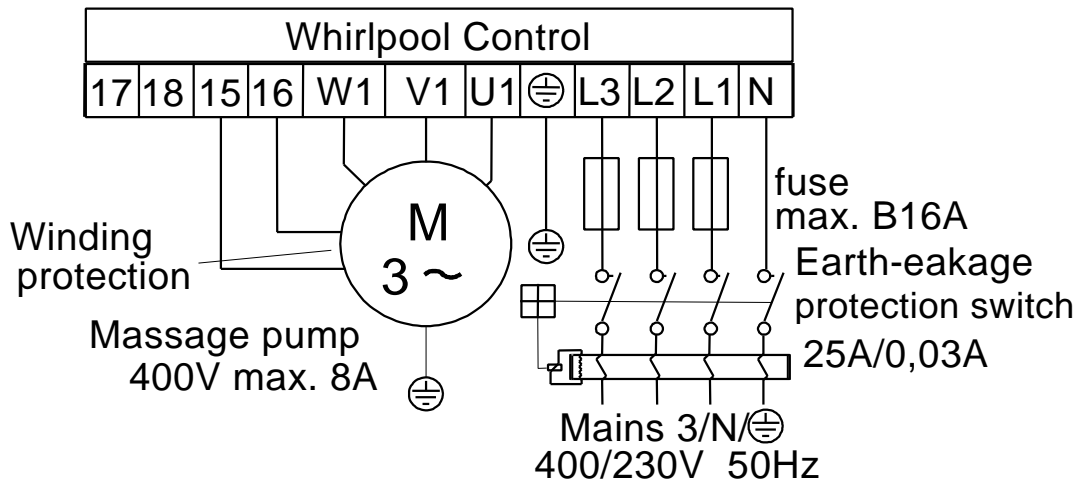

The bridge inserted at the factory between terminals 15 and 16 must be removed when connecting a pump with motor winding protection contact. If no connection is made, it must remain screwed in place. The terminals carry mains voltage!

Supply connection using a 230V alternating current whirlpool pump:

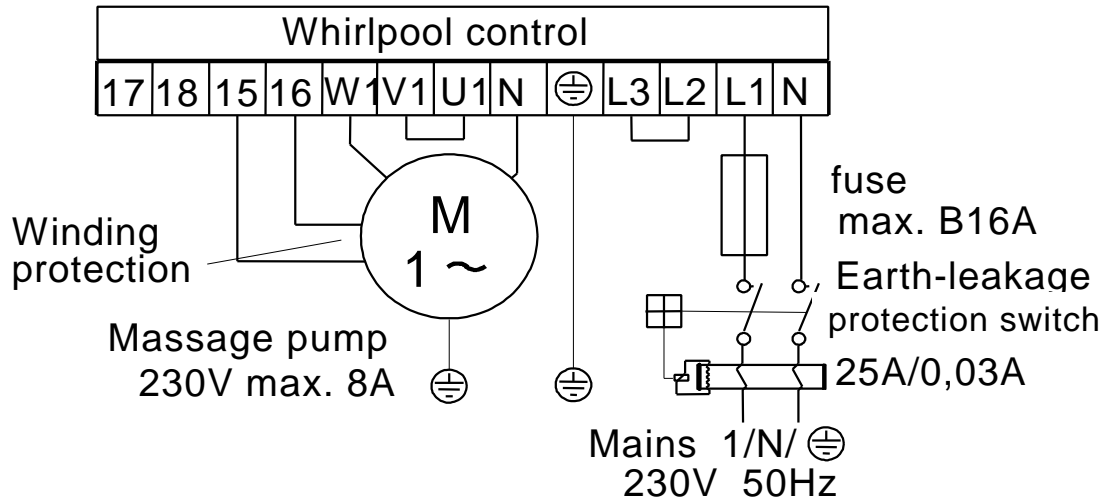

The bridge inserted at the factory between terminals 15 and 16 must be removed when connecting a pump with motor winding protection contact. If no connection is made, it must remain screwed in place. The terminals carry mains voltage!

For the electronic motor protection to work properly, the motor current must be conducted across all 3 moving contacts of the control (terminals L2 and L3, and U1 and V1 bridged, pump connected to W1).

Connection of a coin-operated timer:

The floating contact of a coin-operated timer may be connected to terminals 17 and 18. When a coin is inserted the whirlpool pump, the blower and the light are switched on. The units switch off again at the end of the period set on the coin-operated timer. Both runtime limitations must be deactivated when using a coin-operated timer (see below). In this case, a Sensor armatur must not be connected. The light push button on the front cover does not work when the coin-operated timer is active. The terminals carry mains voltage!

Heating and centralized fault indication:

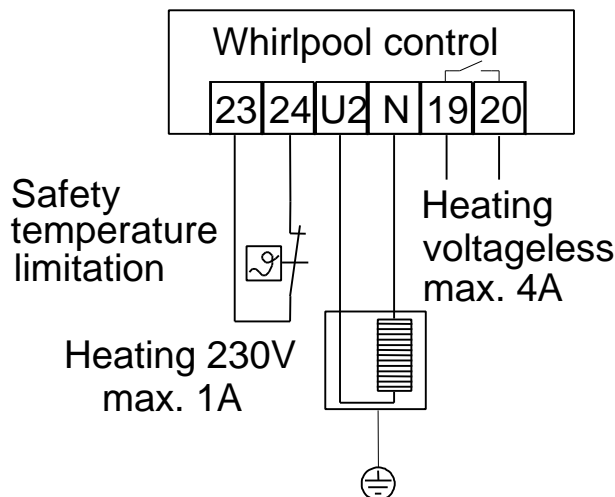

The bridge inserted at the factory between terminals 23 and 24 must be removed when connecting a safety thermal relay. If no connection is made, it must remain screwed in place. The terminals carry mains voltage! When the contact of the safety thermal relay opens, the heating at terminal U2 is switched off. The safety thermal relay does not influence the floating relay contact between terminals 19 and 20. When scaling the

protection device note should be taken of the fact that the current for the heating runs via terminals 23 and 24.

There is a floating relay contact between terminals 19 and 20 in the control unit. As desired, this can be:

- used for controlling the heating, or
- serve as a centralized fault indication (in which case it is closed when a fault is present).
Changing the operating mode: see under Code Switch.

This contact may not be subjected to a load of more than 230V/4A.

Level control and backwash control:

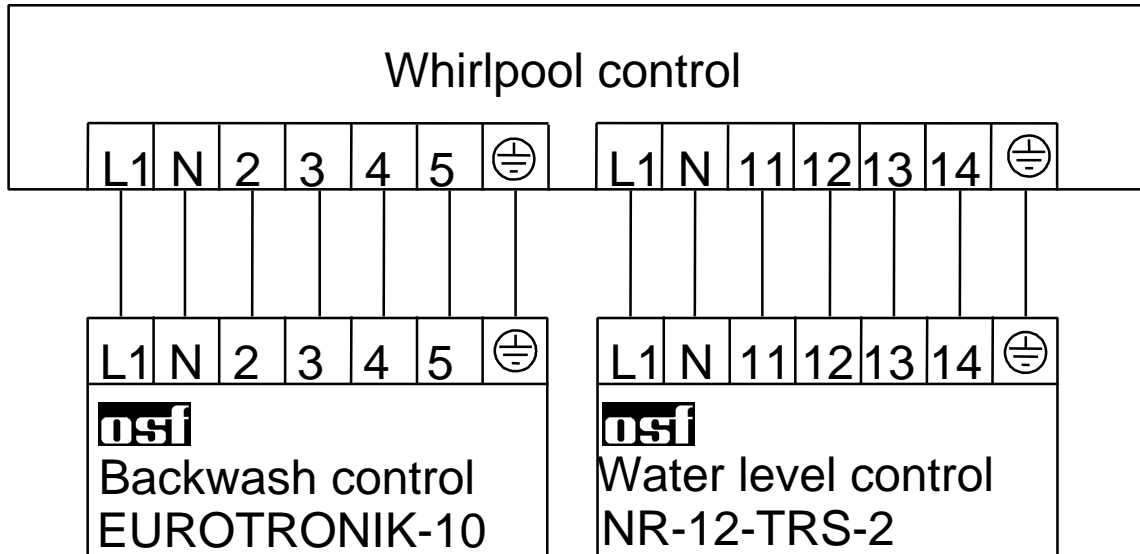

The bridge inserted at the factory between terminals 13 and 14 must be removed when connecting a level control NR-12-TRS-2. If no level control is connected, the bridge must stay screwed in place between these terminals. In this case terminals 11 and 12 remain unused. The terminals carry mains voltage!

The bridge inserted at the factory between terminals 3 and 5 must be removed when connecting a EUROTRONIK-10. If no EUROTRONIK-10 is connected, the bridge must stay screwed in place between these terminals. In this case terminals 2 and 4 remain unused. The terminals carry mains voltage! **CAUTION:** Only the EUROTRONIK-10 (voltageless version from 1994) must be used!

Opening one of the contacts between terminals 13 and 14 or 3 and 5 causes filter pump, chemical control, heating, light and whirlpool pump to switch off immediately.

Closing one of the contacts between terminals 2 and 4 or 11 and 12 causes the filter pump to be force-switched on and the heating and chemical control to switch off.

Lighting, chemical control and remote control switch:

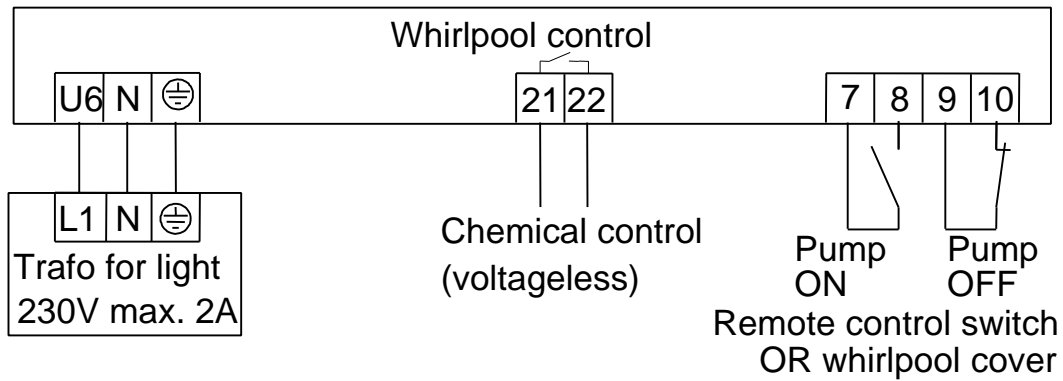

A transformer for the underwater floodlight may be connected to terminal U6. The transformer can be switched on and off by means of a pushbutton key on the front cover (or in the external remote control).

There is a floating relay contact between terminals 21 and 22 in the control unit. This may be used for controlling the chemical control. It is closed during filter operation.

This contact may not be subjected to loads of more than 230V/4A.

A remote control switch or the whirlpool cover may be connected to terminals 7, 8, 9 and 10. These terminals carry mains voltage!

Opening the contact between terminals 9 and 10 causes filter pump, chemical control, heating, whirlpool pump and lighting to switch off immediately.

Closing the contact between terminals 7 and 8 causes the filter unit to switch on.

Connecting filter pump and blower:

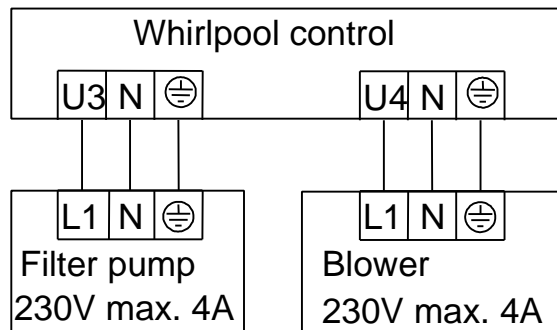

Switching bigger loads:

The sum total of the current input of all equipment connected must not exceed 15A. If necessary, an **nsi** power unit should be used.

Temperature detector:

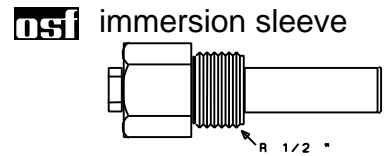
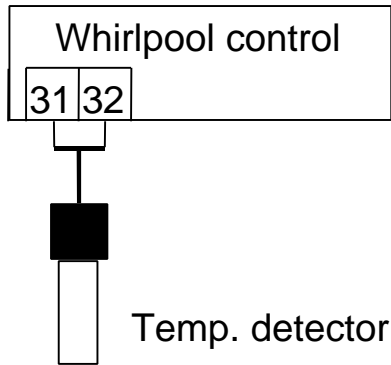

The temperature detector is connected to terminals 31 and 32. This temperature detector is supplied with a 1.5m long cable as standard. If required, this may be extended using a two-core cable (diameter at least 0.5mm²) up to a maximum of 20m. Avoid installing the detector cable near mains cables to rule out any interference.

Since exact temperature control is only possible where there is good heat transmission between temperature detector and whirlpool water, an **OSI** immersion sleeve R 1/2 " (product code 3200200003) must be installed into the pipe system.

The detectors may have any polarity.

External operating panel:

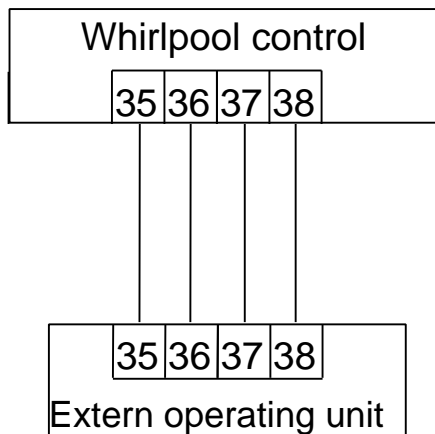

An external operating panel (flush-type, product code 3100000420 or surface-type, product code 3100000410) may be connected to terminals 35-38. A 4-core telephone cable (product code 3100000500) with a length of no more than 50m serves to connect to the whirlpool control. To prevent interference avoid installing the connection cable near mains cables.

The Sensor armatur no. 31 (digital) can be connected to the same terminals in parallel with the operating panel.

Sensor Armatur

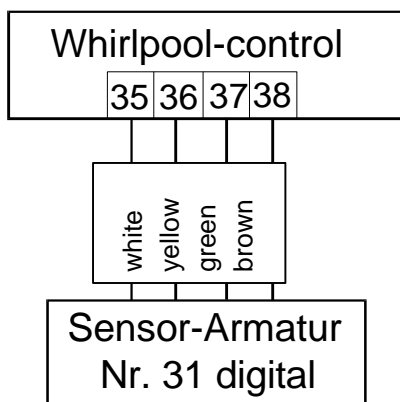

A Sensor armatur no. 31 (digital) (product code 3190000591) may be connected to terminals 35-38. This Sensor armatur is installed in the edge of the tub. A 4-core telephone cable (product code.-3100000500) with a length of no more than 50m serves to connect to the whirlpool control. To rule out any interference avoid installing the connection cable near mains cables.

The Sensor armatur is installed in the edge of the tub in such a way that it is accessible through an inspection opening from below in the event of a service.

Control elements on the front cover:

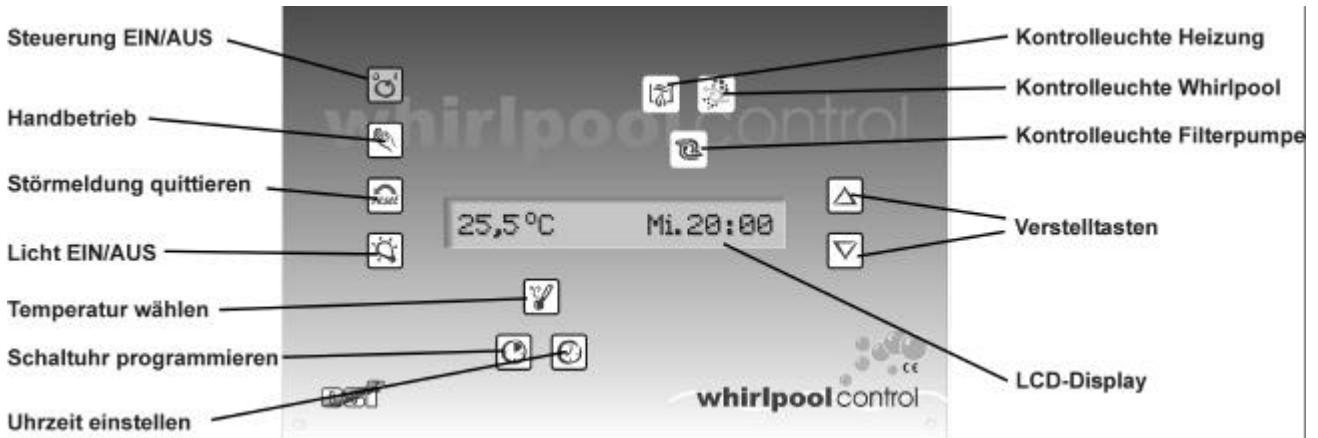



LCD 23,4°C 14:46 Normal operating display, showing current water temperature and time.

LCD 23,4°C Trail-off The filter pump trails off briefly after the heating has been switched off.

LCD Forced sw.-on 13:37 The filter pump has been switched on by the backwash control EUROTRONIK-10 or the level control NR-12-TRS-2.

LCD Pump blocked 13:37 The filter pump has been switched off by the backwash control EUROTRONIK-10, by the level control NR-12-TRS-2, by a remote control switch connected to terminals 9 and 10, or by the motor winding protection switch.

LCD Pump overload! The whirlpool pump has been switched off by the electronic motor protection. To switch the pump on again, the pushbutton key  must be pressed after the pump has cooled down.

LCD Phase missing! The whirlpool pump has been switched off because there not all 3 phases of the three-phase carry current are present. To switch the pump on again, the pushbutton key  must be pressed after the fault has been remedied.

LCD Det. defective 13:37 The temperature control does not operate, because the temperature detector is either not connected or defective.



Control ON/OFF

The entire control system can be switched on or off with this key. **CAUTION!** This does not isolate the control system from supply! This pushbutton key will be lit when the control is switched on.



Manual operation

With this key the filter pump can be switched on manually, independent of the timer clock. The pushbutton key is lit during manual operation.



Acknowledge error message

If the control system identifies an error (e.g. motor protection), this pushbutton key will glow red. This error message must be acknowledged by pressing this key, in order for the normal operation of the system to continue.

**Light ON/OFF**

The underwater floodlight is switched on or off with this key. The key is lit when a load is switched on. The function of the light output is not interlocked with the filter pump.

**CONTROL LAMP PUMP**

This control lamp indicates the operation of the filter pump.

**CONTROL LAMP HEATING**





This control lamp is on when the heating is switched on.

**Control lamp Whirlpool**

This control lamp is lit during operation of the whirlpool. (Whirlpool pump and/or blower)

**Select temperature**





This key is used to select the temperature of the whirlpool water:

1. Press key  ⇒ display shows 23,4° Set-temp
2. With the keys  and  the desired temperature can now be set within a range of 0.1°C to 40°C.
3. If the heating is to be switched off altogether, the temperature must be lowered sufficiently for the message Heating is off to be displayed using the key .

To save the desired temperature press the key marked  again. If no key is pressed during the temperature setting for 10 seconds, the temperature selected last is automatically saved, and the normal operating display is shown again.







**Set time**



This key is used to set the current time:

1. Press key  ⇒ display shows Time: 14:26. If the timer is used as a weekly timer, the appropriate day is also shown.
2. With the keys  and  the current time may now be set.
3. To save the time, press the key  again. If no key is operated for 10 seconds or more during the temperature setting, the time shown last is automatically saved, and the normal operating display is shown again.







**Program timer**

This key is used for programming the integrated timer. The make-time and the break-time must be input in pairs:

1. Press key  ⇒ display shows 1. Pump ON --:--. If the timer is used as a weekly timer, the appropriate day is also shown.
2. With the keys  and , the current make-time may now be set.
3. Press key  ⇒ display shows 1. Pump OFF 0:00
4. Using the keys  and , the current break-time may now be set.

5. Press key  again ⇒ display shows 
6. Other operating times may now be programmed as described under 2-5.
7. To save the operating times, press the key  again. If no key is operated for 10 seconds or longer during the temperature setting, the operating time displayed last is automatically saved, and the normal operating display is shown again.

If operating times have already been programmed, these may be deleted using the key :

1. Press key  repeatedly until the make-time to be deleted is shown in the display 
2. Using the keys  and , set the make-time to  (between 23:59 and 00:00 hours).
3. To delete the operating time, press the key  again. The associated break-time will be deleted as well.



Adjustment keys

Use these keys to program water temperature, time and operating times.

Control elements on the Sensor armatur:

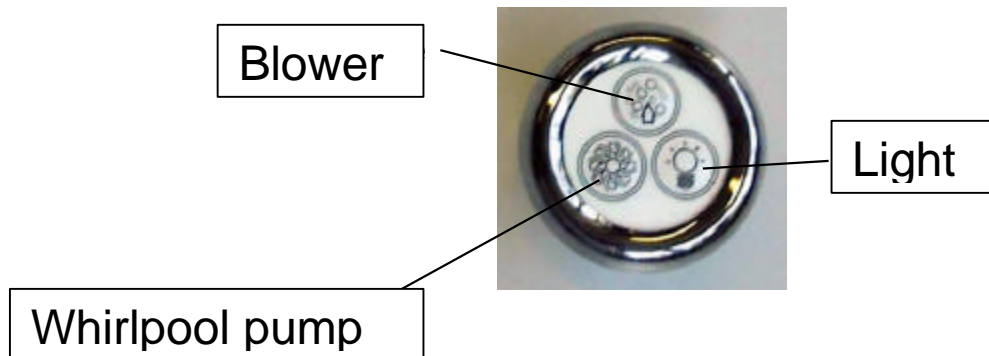

Adjustment of the temperature feedback control:

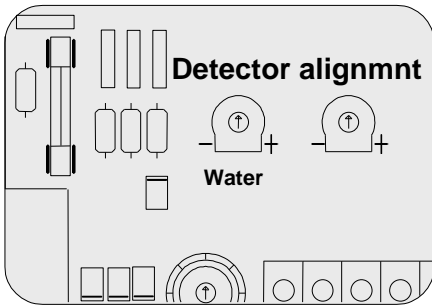

The electronic temperature feedback control and the temperature detector have been aligned with each other at the factory. If the detector is replaced or a detector cable is extended, a new alignment may be required, using the potentiometer in the control device. Turning the potentiometer for the water temperature detector clockwise causes the displayed water temperature to increase.

Fuses:

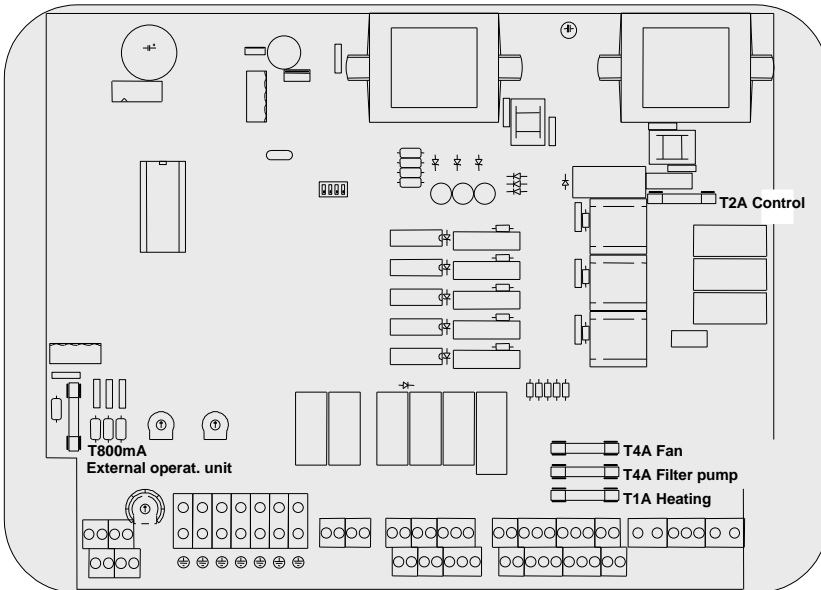

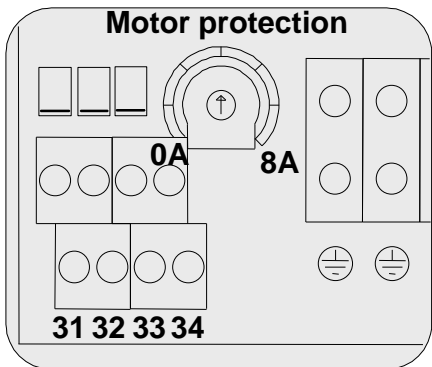

A 2A fine-wire fuse on the printed board inside the equipment protects the electronic control. A 1A fine-wire fuse is provided for the heating and a 4A fine-wire fuse is provided for the filter pump and the blower. Short-circuit protection for the whirlpool pump must be provided by an on-site back-up fuse of no more than 16A.

Electronic motor protection:



The three-phase whirlpool pump is protected against damage resulting from overload by an electronic motor protection. To do so the motor protection must be set to the nominal current of the whirlpool pump (see nameplate of the pump). The setting controller for the motor protection is located in the terminal box, protected against accidental adjustment. If the nominal current of the pump is not known, the motor protection can be set using the following procedure.

1. Turn the adjustment screw of the motor protection clockwise up to the stop.
2. Switch on the pump
3. Turn the adjustment screw slowly counterclockwise until the motor protection is triggered and the red fault message  is lit.
4. Turn the adjustment screw clockwise by a few degrees (approx. 10%).

Unlock the motor protection with the  key – fault message goes off and whirlpool pump runs.

Coding switch:

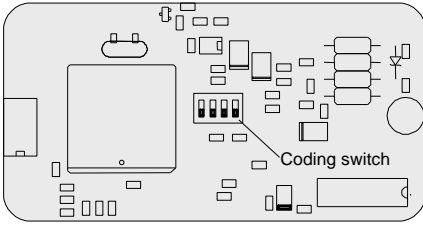

In order to use the whirlpool control universally for the various different whirlpool systems, a coding switch is provided on the printed board which can be used to set different operating modes. The following functions can be set:

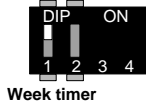
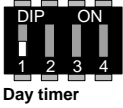

Day or week timer:

Coding switch 1 can be used to select whether the integrated timer should use the same filter times every day (day timer), or whether the filter times should be programmed individually for each weekday (week timer). In the OFF position (lower switch position) it operates as a day timer, in the ON position (upper switch position) it operates as a week timer.

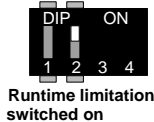
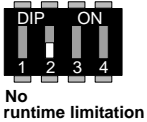

Runtime limitation whirlpool pump:

Coding switch 2 can be used to activate the runtime limitation of the whirlpool pump. In the ON position (upper switch position) the whirlpool pump switches off automatically once the preset period has expired. In the OFF position (lower switch position) the whirlpool pump needs to be switched off by pressing the key.



Centralized fault indication:

The function of the relay contact between terminals 19 and 20 can be changed over using coding switch 3:

In the OFF position (lower switch position) the contact is closed when the heating is switched on and may then be used, for example, to control a central heating system. In the ON position (upper switch position) this contact is closed, if a fault is present (motor protection or detector break).

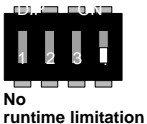

Runtime limitation blower:

Coding switch 4 can be used to activate a runtime limitation for the blower. In the ON position (upper switch position) the blower switches off automatically once the preset period has expired. In the OFF position (lower switch position) the blower needs to be switched off by pressing the key.

When shipped, all 4 coding switches are in the OFF position.

Service Terminal:

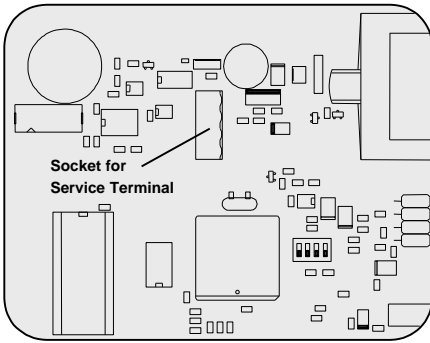

To adapt the control to the various different whirlpool systems in the best possible way and to make start-up and fault diagnosis easier, this control may be connected to an osf Service Terminal (product code 3010000900). The connection plug for this is on the printed board inside the housing. **The control system must be isolated from supply before opening the case and plugging in the Service Terminal!** After switching on the control device the first 4 lines of the diagnosis text are shown on the display of the Service Terminal, e.g.:

Filter operation
Temp. reached
Water: 23.0°
Current (U1) 0.0A°



Operating mode of filter system
 Operating mode of heating
 Measured water temperature
 Measured current input

More lines can be shown by using the keys \triangle and ∇ . If necessary, the values in the **top** line can be changed by using the \leftarrow key.

1. Operating mode of the filter system

This line displays the current operating mode of the filter system.

The following display options are possible:

<i>Control off</i>	The control has been switched off with the key  .
<i>Filter system off</i>	The filter system is switched off.
<i>Filter operation</i>	The filter system has been switched on by the timer, by the manual switch  on the front cover, or by the remote control switch.
<i>Trail-off period</i>	After the heating is switched off the filter pump will trail off.
<i>Forced switching on</i>	The filter pump has been switched on by the backwash control EUROTRONIK-10 or the level control NR-12-TRS-2.
<i>Priority mode</i>	The filter pump has been switched on by the temperature control outside the set filtering periods, because this works in priority mode or because the nighttime temperature reduction is active.
<i>Pump is blocked</i>	The filter pump has been switched ON temporarily by the backwash control EUROTRONIK-10, the level control NR-12-TRS-2, or the remote control switch, or it has been switched OFF temporarily by the motor winding protection contact.
<i>Motor protection</i>	The whirlpool pump has been switched off because the electronic motor protection tripped.
<i>Power phase is missing</i>	The whirlpool pump has been switched off because current is not present in all 3 power phases.

2. Operating mode of the heating system

This line displays the current operating mode of the temperature control.

The following display options are possible:

<i>Controller off</i>	The heating system has been switched off using the adjustment keys on the front cover.
<i>Heating off</i>	The heating is switched off outside the filtering periods.
<i>Heating blocked</i>	The heating is switched off because a forced switching on by the EUROTRONIK or the NR-12-TRS-2 is present, or because the filter pump has been switched off due to a fault condition.
<i>Temp. Reached</i>	The heating is switched off because the setpoint temperature has been reached.
<i>Heating on</i>	The heating is switched on because the water temperature is below the preset setpoint temperature.

3. Water temperature

This line displays the current water temperature. If the displayed temperature does not match the actual temperature, it can be adjusted using the adjustment controller on the printed board (see section on Temperature Control). Turning the adjustment controller clockwise causes the value to be increased. If the temperature detector is defective, "Detector Break" is displayed.

4.-6. Motor current

This line shows the current power input of the whirlpool pump in the 3 phases of the three-phase supply.

7. Motor protection



This line shows the preset trip current of the electronic motor protection.

8. Nighttime temperature reduction

This line shows the value that the water temperature is to be reduced by. This value can be adapted to the requirements of the respective system, if it is displayed in the **top** line of the Service Terminal:

1. After pressing the key  the filter system is switched off and the following text is displayed:

Night reduce: 4,0
 Nighttime temp.
 reduction outside
 filtering periods

2. The nighttime reduction temperature can be changed using the keys  and . The smallest value that can be set is 0 °C and the largest is 10 °C.
3. If the key  is operated again, the normal diagnosis display is shown and the filter system continues operating. The set value is saved automatically.

A reduced nighttime temperature of 0 °C is set at the factory.

CAUTION: The nighttime temperature reduction is switched on and off in the following menu item, Priority Connection of the Heating System, below.

9. Priority mode of the heating system:

This line shows whether the temperature control has priority over the adjustment of the filtering periods. If priority mode is set, the filter pump can be switched on by the temperature control even outside the set filtering periods. Without priority the temperature control will only operate during the filtering periods. Priority must be switched on for nighttime temperature reduction. The priority mode may be changed with the Service Terminal.



The following display options are possible:

<i>Priority OFF</i>	The heating will only operate during the filtering periods.
<i>Priority ON</i>	The temperature control works also outside the filtering periods. If the water temperature falls below the set setpoint temperature, filter pump and heating switch on automatically.

If the operating mode of the priority is shown in the **top** line of the Service Terminal, the priority may be switched on or off:

1. After pressing the key , the filter system is switched off and the following text is displayed:

Priority: OFF
Heating outside
filtering periods

2. The  key is used to switch priority on, and the  key is used to switch it off.
3. If the key  is operated again, the normal diagnosis display is shown and the selected condition is saved.



The priority of the heating is switched off when shipped.

10. Minimum time of the heating system

This line displays how long the heating is switched on or off by the temperature control, in order to avoid switching frequencies that are too short. This value can be adapted to the requirements of the respective heating system, if it is shown in the **top** line of the Service Terminal:

1. After pressing the key , the filter system is switched off and the following text is displayed:

Min. Heating: 120s
Min. switching
period of
heating

2. The minimum period can be adjusted in increments of 10s with the keys  and . The smallest value that can be set is 10s and the largest is 1800s (30 minutes).
3. If the key  is operated again, the normal diagnosis display is shown and the filter system continues operating. The set value is saved automatically.



The time set here only influences the behaviour of the temperature control. When the filter pump is switched off the heating is switched off without delay, regardless of the set waiting time. A minimum period of 2 minutes is set at the factory.

11. Runtime limitation for the blower and the whirlpool pump

This line displays how long the blower and the whirlpool pump are to operate after switching on before they are switched off automatically. This value can be set individually, if it is shown in the **top** line of the Service Terminal:

1. After pressing the key , the filter system is switched off and the following text is displayed:

Runtime:	10s
Time limitation for fan and whirl pump.	

2. The runtime can be changed using the keys  and . The smallest value that can be set is 300s and the largest is 900s.
3. If the key  is operated again, the normal diagnosis display is shown and the filter system continues to operate. The set value is saved automatically.



A runtime of 600 seconds is set when the system is shipped.

12. Trail-off period of the filter pump

This line shows how long the filter pump trails off after the heating is switched off. This value can be adapted to the requirements of the filter system, if it is shown in the **top** line of the Service Terminal:

4. After pressing the key , the filter system is switched off and the following text is displayed:

Trail-off:	10s
Trail-off time of Filter pump after the heating	

5. The trail-off time can be changed using the keys  and . The smallest value that can be set is 0s and the largest is 1800s.
6. If the key  is operated again, the normal diagnosis display is shown and the filter system continues to operate. The set value is saved automatically.

The trail-off of the filter pump is switched off when shipped (Trail-off period = 0).

13. Pump operating time

This line displays the total operating time of the filter pump.

14. Whirlpool pump operating time (whirl time)

This line displays the total operating time of the whirlpool pump (whirl time).

15. Blower operating time

This line displays the total operating time of the blower.

16. Heating operating time

This line displays the total operating time of the heating.

17. Motor protection counter

This line shows how often the electronic motor protection was triggered.

18. Phase failure counter

This line shows how often the whirlpool pump was switched off due to a power phase failure.

19. Backwash counter

This line shows how often the EUROTRONIK initiated a backwash procedure.

The following lines enable the service technician to check the input signals and the output relays of the filter control.

20. Forced switching on of the NR-12-TRS-2:

This line shows whether the level control NR-12-TRS-2 has requested a forced switching on.

The following displays are possible:

Forced switching on OFF No forced switching on or terminals 11 and 12 are not connected

Forced switching on ON Forced switching on requested or terminals 11 and 12 are connected

21. EUROTRONIK backwash signal:

This line shows whether the EUROTRONIK switches the filter pump on during backwashing or rinsing.

The following displays are possible:

EUROTRONIK OFF No switch-on command issued by the EUROTRONIK

EUROTRONIK ON The EUROTRONIK has switched the filter pump on

22. Remote control switch:

This line shows whether the remote control switch connected to terminals 7 and 8 has switched on the filter system.

The following displays are possible:

Remote control switch OFF The remote control switch is switched off (contact open)

Remote control switch ON The remote control switch is switched on (contact closed)

23. Coin-operated timer:

This line shows the switching state of the coin-operated timer connected to terminals 17 and 18.

The following displays are possible:

Coin-operated timer: OFF The contact in the coin-operated timer is open

Coin-operated timer: ON The contact in the coin-operated timer is closed

24. Interlocking:

This line shows whether filter system, light and whirlpool pump have been switched off by EUROTRONIK, NR-12-TRS-2, by the motor winding protection contact or by a remote control switch connected to terminals 9 and 10.

The following display options are possible:

<i>Interlocking OFF</i>	The pump is switched off (one of the contacts is open)
<i>Interlocking ON</i>	The operation of the pump is enabled (all interlocking contacts are closed)

25. Operating mode of the timer:

This line shows whether the integrated timer operates as a day or a week timer. The operating mode of the timer can be selected with the coding switch no. 1.

The following display options are possible:

<i>Day timer</i>	The programmed switching intervals are identical for each day
<i>Week timer</i>	Different switching intervals can be programmed for each weekday

The timer is shipped as a day timer.

26. Function of terminals 19 and 20:

This line shows whether the relay contact between terminals 19 and 20 serves to control an additional heating unit, or as a centralized fault indication. The function of this contact may be changed with the coding switch no. 3.

The following displays are possible:

<i>19 & 20 heating</i>	Coding switch no. 3 is in the OFF position. The relay contact is closed, if the temperature control switches the heating on.
<i>19 & 20 fault</i>	Coding switch no. 3 is in the ON position. The relay contact is closed, if a fault is present.

The contact is shipped ready for controlling an additional heating unit.

27. Runtime limitation of the whirlpool pump:

This line shows whether the runtime limitation for the whirlpool pump is switched on or off. The operating mode can be selected with the coding switch no. 2.

The following displays are possible:

<i>Runtime limit. OFF</i>	The runtime limitation is switched off.
<i>Runtime limit. ON</i>	The runtime limitation is switched on.

The runtime limitation is switched off when shipped.

28. Runtime limitation of the blower:

This line shows whether the runtime limitation for the blower is switched on or off. The operating mode can be selected with the coding switch no. 4.

The following displays are possible:

Runtime blower OFF The runtime limitation is switched off.

Runtime blower ON The runtime limitation is switched on.



The runtime limitation is switched off when shipped.

29. Filter pump

If the operating mode of the filter pump is shown in the **top** line of the Service Terminal, the pump can be switched on or off manually:

4. After pressing the key , the filter system is switched off and the following message is displayed:

Filter pump: OFF
Pump can be
switched
manually



5. The filter pump can be switched on with the  key and switched off with the  key.
6. If the key  is pressed again, the default diagnosis display is shown and the filter system continues to operate.

30. Whirl pump

If the operating mode of the whirl pump (whirlpool pump) is shown in the **top** line of the Service Terminal, the pump can be switched on or off manually:

7. After pressing the key , the filter system is switched off and the following message is displayed:

Whirl pump: OFF
Output can be
switched
manually



8. The whirl pump can be switched on with the  key and switched off with the  key. **CAUTION! The electronic motor protection is disabled in this operating mode!**
9. If the key  is pressed again, the default diagnosis display is shown again and the filter system continues to operate.

31. Blower

If the operating mode of the blower is shown in the **top** line of the Service Terminal, the blower can be switched on or off manually:

10. After pressing the key , the filter system is switched off and the following message is displayed:

Fan: OFF
Output can be
switched
manually



11. The blower can be switched on with the  key and switched off with the  key.
12. If the key  is pressed again, the default diagnosis display is shown again and the filter system continues to operate.

32. HEATING

If the operating mode of the heating is shown in the **top** line of the Service Terminal, it can be switched on or off manually:

1. After pressing the key , the filter system is switched off and the following message is displayed:

Heating	
MANUAL OPERATN	
Heating:	OFF
Filter pump:	OFF



2. The heating can be switched on with the  key and switched off again with the  key. The filter pump is switched on automatically as well.
3. If the  key is pressed again, the normal diagnosis display is shown and the filter system continues to operate.

33. Chemical control

If the operating mode of the chemical control is shown in the **top** line of the Service Terminal it can be switched on or off manually:

1. After pressing the key , the filter system is switched off and the following message is displayed:

Dosing:	
Filter pump:	OFF



2. The chemical control can be switched on with the  key and switched off with the  key. The filter pump is switched on automatically as well.
3. If the  key is pressed again, the normal diagnosis display is shown and the filter system continues to operate.

34. Fault message

If the operating mode of the centralized fault indication is shown in the **top** line of the Service Terminal, it can be switched on or off manually:

1. After pressing the key , the filter system is switched off and the following message is displayed:

Fault message OFF
MANUAL OPRNT

2. The centralized fault indication can be switched on with the  key and switched off again with the  key.
3. If the  key is pressed again, the normal diagnosis display is shown and the filter system continues to operate.



This function can only be used, if coding switch no. 3 is in the ON position.

35. Lighting

If the operating mode of the light output is shown in the **top** line of the Service Terminal it can be switched on or off manually:

1. After pressing the key , the filter system is switched off and the following message is displayed:

Light: OFF
Output can be
switched
manually

2. The lighting output can be switched on with the  key and switched off with the  key.
3. If the  key is pressed again, the normal diagnosis display is shown and the filter system continues to operate.

Computer interface:

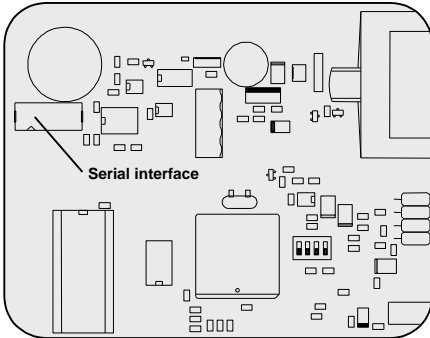

In order to be able to archive the values set with the service terminal and the contents of the service hours meter, a PC can be connected to the integrated serial interface using a suitable cable. The program supplied with the cable reads the values saved in the filter control, displays them on screen in an easy-to-read format and, if desired, saves them on the PC.

We hope you enjoy relaxing in your whirlpool.